

Talenti[®]

OUTDOOR LIVING

Price list - eu
2025

KITCHEN

COMPOSIZIONE BASE 3 MODULI - ASSEMBLY OF A BASE WITH 3 MODULES

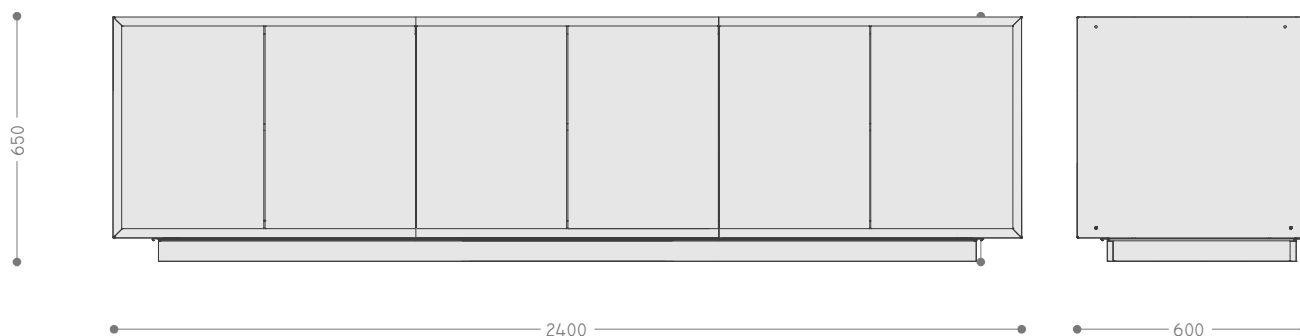
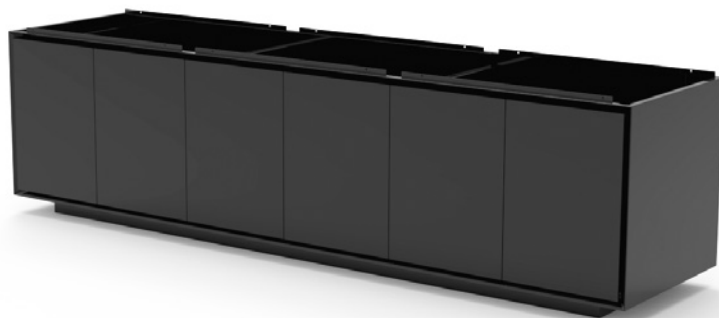

Struttura in acciaio zinco magnesio e alluminio (Magnesit), verniciatura bianco RAL 9003 o nero RAL 9004 alte temperature testurizzato.
6 ante a battente con maniglia ad incasso gola, apertura 125° a sgancio rapido e chiusura blumotion.
Misure 2400x600x650 h - peso 140 kg.
Dimensioni interne del vano 65x54x49 h

Structure in zinc magnesium steel and aluminium (Magnesit), white RAL 9003 or black RAL 9004 high temperature, textured painting.
6 swing doors with recessed handles, fast release 125° opening and blumotion latch.
Dimensions: 2400x600x650 h - weight 140 kg.
Internal dimensions of the compartment 65x54x49 h

COMPOSIZIONE BASE 2 MODULI - ASSEMBLY OF A BASE WITH 2 MODULES

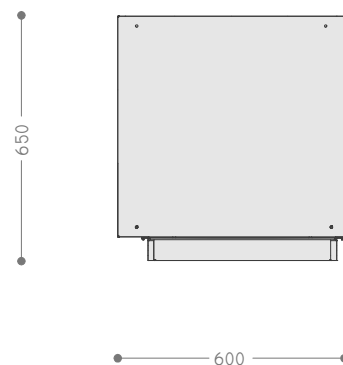
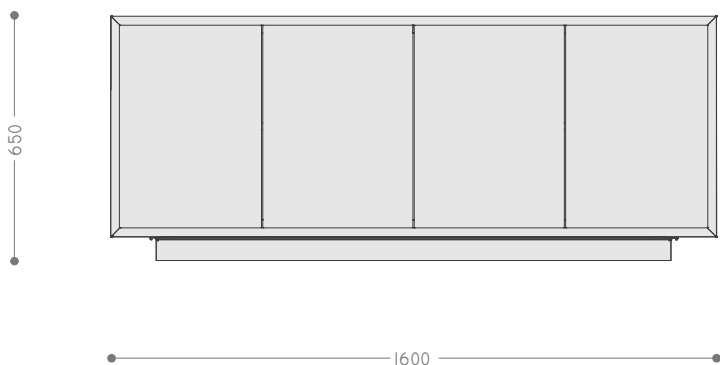

Struttura in acciaio zinco magnesio e alluminio (Magnesit), verniciatura bianco RAL 9003 o nero RAL 9004 alte temperature testurizzato.
4 ante a battente con maniglia ad incasso gola, apertura 125° a sgancio rapido e chiusura blumotion.
Misure 1600x600x650 h - peso 95 kg.
Dimensioni interne del vano 65x54x49 h

Structure in zinc magnesium steel and aluminium (Magnesit), white RAL 9003 or black RAL 9004 high temperature, textured painting.
4 swing doors with recessed handles, fast release 125° opening and blumotion latch.
Dimensions: 1600x600x650 h - weight 95 kg.
Internal dimensions of the compartment 65x54x49 h

COMPOSIZIONE BASE 3 MODULI CON ANTE IN LEGNO DI ACCOYA NATURAL TEAK

ASSEMBLY OF A BASE WITH 3 MODULES WITH DOORS IN ACCOYA WOOD

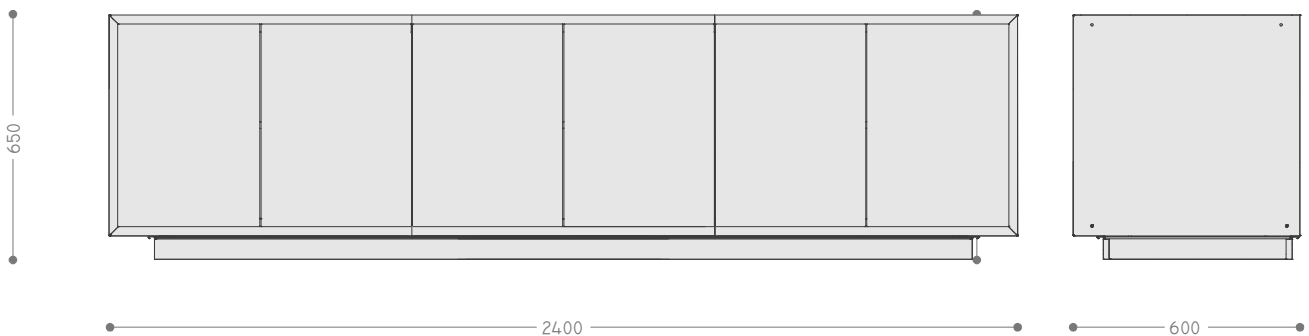
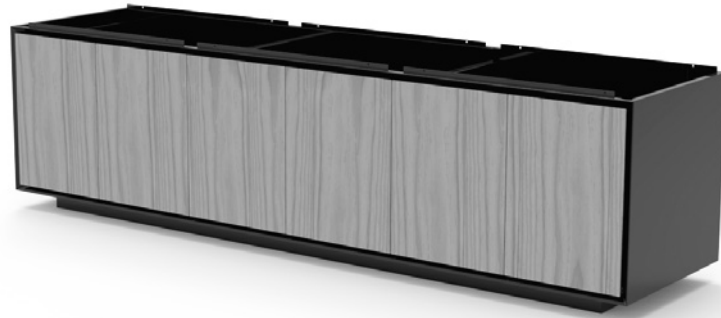

Struttura in acciaio zinco magnesio e alluminio (Magnesit), verniciatura bianco RAL 9003 o nero RAL 9004 alte temperature testurizzato.

6 ante a battente in legno di accoya tinto natural teak con maniglia ad incasso gola, apertura 125° a sgancio rapido e chiusura blumotion.

Misure 2400x600x650 h - peso 140 kg.

Dimensioni interne del vano 65x54x49 h

Structure in zinc magnesium steel and aluminium (Magnesit), white RAL 9003 or black RAL 9004 high temperature, textured painting.

6 swing doors in accoya wood, natural teak colored with recessed handles, fast release 125° opening and blumotion latch.

Dimensions: 2400x600x650 h - weight 140 kg.

Internal dimensions of the compartment 65x54x49 h

COMPOSIZIONE BASE 2 MODULI CON ANTE IN LEGNO DI ACCOYA NATURAL TEAK

ASSEMBLY OF A BASE WITH 2 MODULES WITH DOORS IN ACCOYA WOOD

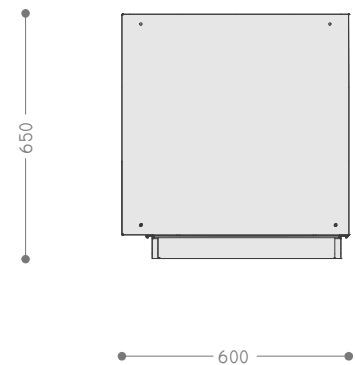
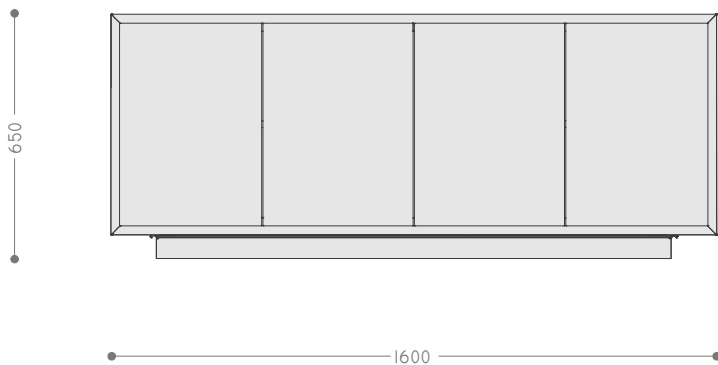

Struttura in acciaio zinco magnesio e alluminio (Magnesit), verniciatura bianco RAL 9003 o nero RAL 9004 alte temperature testurizzato.

4 ante a battente in legno di accoya tinto natural teak con maniglia ad incasso gola, apertura 125° a sgancio rapido e chiusura blumotion.

Misure 1600x600x650 h - peso 95 kg.

Dimensioni interne del vano 65x54x49 h

Structure in zinc magnesium steel and aluminium (Magnesit), white RAL 9003 or black RAL 9004 high temperature, textured painting.

4 swing doors in accoya wood, natural teak colored with recessed handles, fast release 125° opening and blumotion latch.

Dimensions: 1600x600x650 h - weight 95 kg.

Internal dimensions of the compartment 65x54x49 h

MODULI DISPONIBILI - AVAILABLE MODULES



Modulo Barbecue

Struttura in acciaio alluminato/acciaio inox, verniciatura nero RAL 9004 alte temperature testurizzato.

N.3 bruciatori a Gas con potenza totale 7,5 kw con sistema a irradiazione Fire Core esclusivo che sfruttando l'abbinamento tra speciali bruciatori e deflettori che agiscono per irradiazione, permette di avere una temperatura uniforme su tutta la superficie con caratteristiche di bassi consumi ed efficienza sviluppata dai bruciatori da 2,5kw. Cottura diretta.

Misure 800x600x250 h - peso 52 kg.

Consigliamo bombola 10 L ribassata.

Barbecue module

Aluminium/Stainless steel structure, black RAL 9004 high temperature, textured painting.

N.3 gas burners with total power 7,5 kw with exclusive irradiance Fire Core system, based on the combined use of special burners and deflectors, which allows the maintaining of a stable temperature all over its surface. The system is characterised by low consumption and efficiency, guaranteed by 2,5kw burners. Direct cooking.

Dimensions 800x600x250 h - weight 52 kg.

We recommend a lowered 10 L tank.

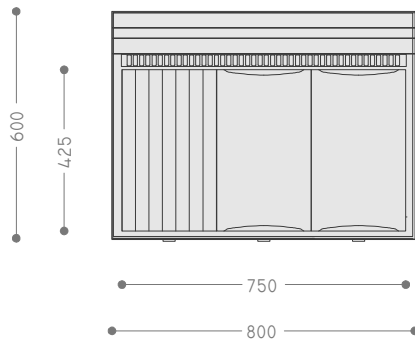

Modulo Barbecue con coperchio

Struttura in acciaio alluminato/acciaio inox, verniciatura nero RAL 9004 alte temperature testurizzato.

N.2 bruciatori a Gas con potenza totale 5 kw con sistema a irradiazione Fire Core, che sfruttando il coperchio coibentato, permetterà scegliere la modalità, la temperatura e la tecnica di cucina da adottare. Possibilità di cottura diretta/indiretta.

Misure 800x600x470 h - peso 59 kg.

Consigliamo bombola 10 L ribassata.

Barbecue module with lid

Aluminium/Stainless steel structure, black RAL 9004 high temperature, textured painting.

N.2 gas burners with total power 5 kw with a Fire Core irradiation, which, taking advantage of the insulated lid, will allow you to choose the method, temperature and cooking technique to adopt. Possibility of direct/indirect cooking.

Dimensions 800x600x470 h - weight 59 kg.

We recommend a lowered 10 L tank.

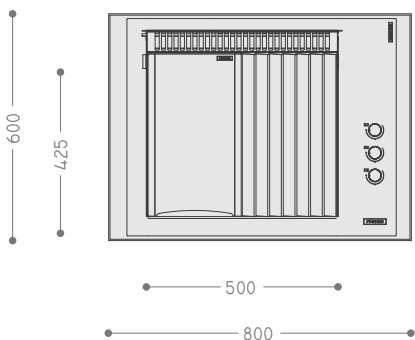

MODULI DISPONIBILI - AVAILABLE MODULES

Modulo Piano cottura ad induzione



Struttura modulo in alluminio.
4 Zone cottura da 1800/3000 W
Potenza massima assorbita regolabile a 5 livelli
(2.8 kW / 3.5 kW / 4.5 kW / 5.8 kW / 7 kW)
Funzione Booster - 2 zone Bridge
Vetroceramica nero sp 4mm
Misure 800x600x250 h - peso 39 kg.

Induction hob module

Aluminium frame module.
4 cooking zones 1800/3000 W
Maximum power input adjustable to 5 levels
(2.8 kW / 3.5 kW / 4.5 kW / 5.8 kW / 7 kW)
Booster function - 2 Bridge zones
4 mm glass-ceramic
Dimensions 800x600x250 h - weight 39 kg.

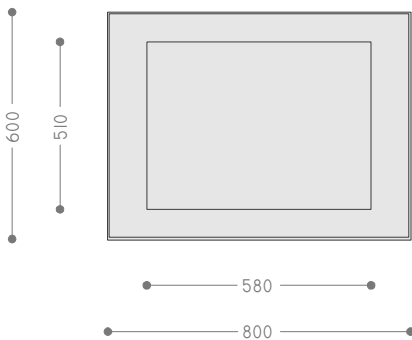

bridge



booster



slide touch



power
management



Modulo Lavello

Struttura modulo in alluminio.
Vaschetta (Foster) in acciaio inox AISI 304 - Sottotop
Finitura spazzolato - 1 vasca 340x400 mm
Miscelatore monocomando per lavello con canna piatta girevole.
Flessibili di alimentazione F3/8".
Finitura acciaio inox.
Misure 800x600x250 h - peso 37 Kg.

Sink module

Aluminium frame module.
Stainless steel AISI 304 sink (Foster) - Undermount sink
Brushed finish- 1 basin 340X400 mm
Single-lever sink mixer, flat swivel spout. 3/8"
female connection hoses.
Stainless steel finishing.
Dimensions 800x600x250 h - weight 37 kg.

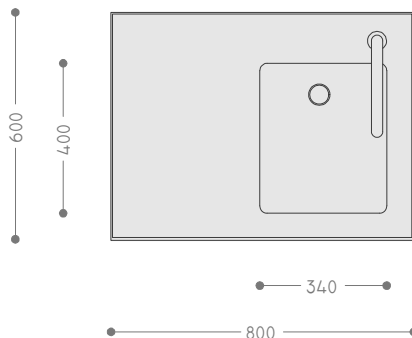

MODULI DISPONIBILI - AVAILABLE MODULES



Modulo piano lavoro

Struttura modulo in alluminio.
Modulo neutro con piano in gres spessore
9 mm colore effetto cemento.
Misure 800x600x250 h - peso 34 kg.

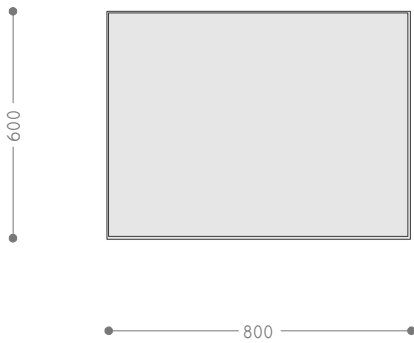

Neutral countertop module

Aluminium frame module.
Neutral module with gres top 9 mm thick
concrete effect color.
Dimensions 800x600x250 h - weight 34 kg.

OPTIONAL DISPONIBILI - *OPTIONALS AVAILABLE*

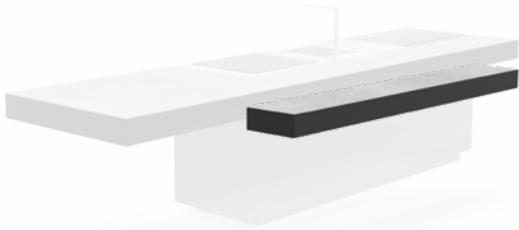

Snack

Struttura modulo in alluminio.

Piano a sospensione con top in gres
misura disponibili:

1600x350x130 - peso 30 kg, cucina 2 moduli

2400x350x130 - peso 48 kg, cucina 3 moduli

Snack bar

Aluminium frame module.

Hanging kitchen gres top:

dimensions 1600x350x130 - weight 30 kg, 2 modules

dimensions 2400x350x130 - weight 48 kg, 3 modules

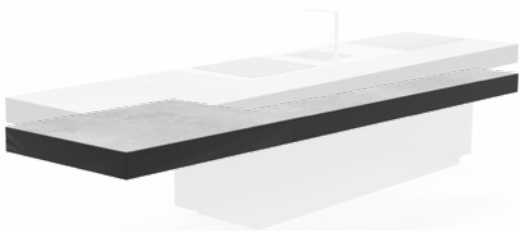

Penisola

Struttura modulo in alluminio.

Piano a sospensione con top in gres
misure 1200x950x130 - peso 54 kg

*abbinabile solo allo snack e disponibile solo
alla base 3 moduli

Peninsula

Aluminium frame module.

Hanging gres top dimensions 1200x950x130 - weight 54 kg

*only compatible with the snack and just available in the
base with 3 modules

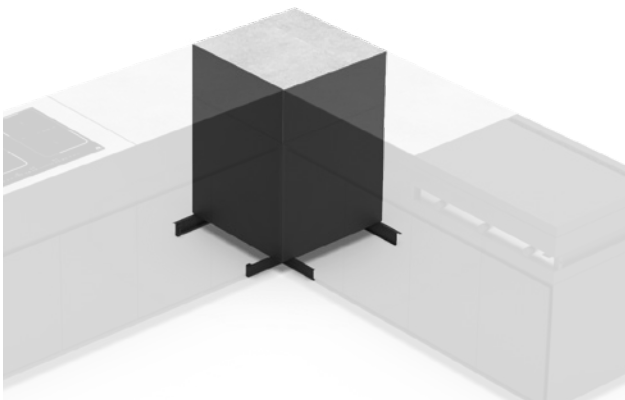

Base angolo con piano lavoro

Base chiusa con piano in gres spessore

9 mm colore effetto cemento

misura 600x600x900 - peso 75 kg

*La base angolo non è predisposta per l'applicazione di
penisola o snack. Utilizzabile esclusivamente come
connessione tra basi 2 moduli o basi 3 moduli.

Corner base with neutral countertop

Closed base with gres top 9 mm thick concrete

dimensions 600x600x900 - weight 75 kg

*The corner base is not suitable for peninsula or snack
bar and can be used as a connector between bases with
3 modules or bases with 2 modules

OPTIONAL DISPONIBILI - *OPTIONALS AVAILABLE*

Cassettiera

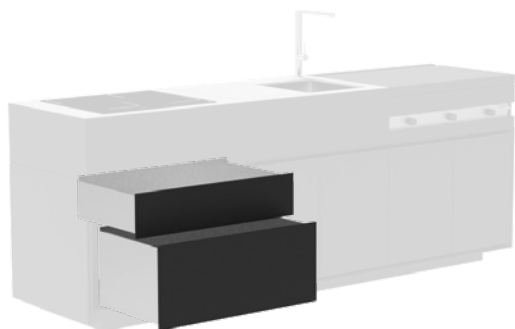

Struttura in acciaio inox e frontale in alluminio verniciato.
Dimensioni interne: 665x475x110mm (superiore),
665x475x210mm (inferiore).

Struttura di supporto della cassettera in zinco magnesio verniciato e guide BLUM Momento.

*nella base 3 moduli non installabile nel vano centrale.

Drawer

Structure is made of Stainless Steel and front panel is made of painted aluminum.

Internal dimensions: 665x475x110mm (upper),
665x475x210mm (lower).

Support structure of the dresser is made of painted magnesium zinc and BLUM Momento guides.

*in the 3 modules base uninstallable in the center compartment.

Frigorifero



Capacità: 75 litri. Peso: 33 Kg.

Dimensioni interne: 490x442x271mm

Alimentazione: 12/24 Vdc. Potenza: 38W

Luce interna LED.

*non installabile in corrispondenza del modulo lavello.

Fridge

Capacity: 75 liters. Weight: 33 Kg.

Internal dimensions: 490x442x271mm

Power supply: 12/24 Vdc. Power: 38W

LED interior light.

*uninstallable under the sink module

Cantinetta



Capacità: 23 litri - 8 bottiglie

Intervallo temperatura da 11°C a 18°C. Schermo LED

Funzionamento termoelettrico, sistema antivibrazione

4 ripiani regolabili. Peso netto 10 kg.

Consumo (kwh/24h) 0.52

Wine cellar

Volume capacity: 23 liters-8 bottles

Temperature range 8°C to 18°C. LED Screen

Thermoelectric functioning, anti-vibration system

4 adjustable shelves. Net weight 10 kg.

power consumption (kwh/24h) 0.52

OPTIONAL DISPONIBILI - *OPTIONALS AVAILABLE*

Frigorifero mini bar

Capacità volume 25 litri
peso netto 12 kg



Minibar fridge

Volume capacity 25 liters
Net weight 12 kg



Ice maker

Capacità di produzione giornaliera: 12 kg
Capacità vassoio d'acqua: 2.1L
Ciclo di produzione: 10 a 13 minuti
2 formati di ghiaccio potenza: 150W

Ice maker

Daily production capacity: 12 kg
Water tank capacity: 2.1L
Production cycle: 10 to 13 minutes
2 ice power formats: 150W

ELEMENTI D'ARREDO - FURNISHING ELEMENTS

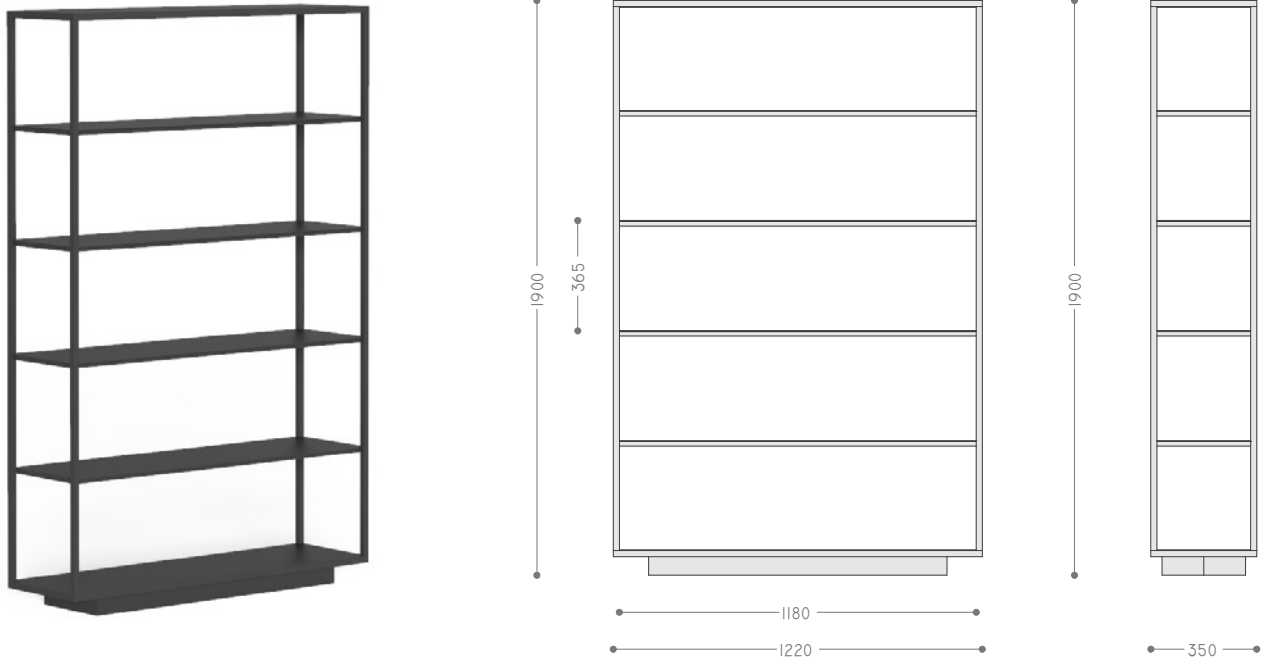

Modulo scaffale 120x190

Struttura in acciaio zinco magnesio e alluminio (Magnesit), verniciatura bianco RAL 9003 o nero RAL 9004 alte temperature testurizzato. Scaffale con mensole metalliche removibili e regolabili. Misure 1220x1900x350 - peso 50 kg

Shelf module 120x190

Structure in zinc magnesium steel and aluminium (Magnesit), white RAL 9003 or black RAL 9004 high temperature, textured painting. Shelf with removable and adjustable metal shelves. Dimensions 1220x1900x350 - weight 50 kg

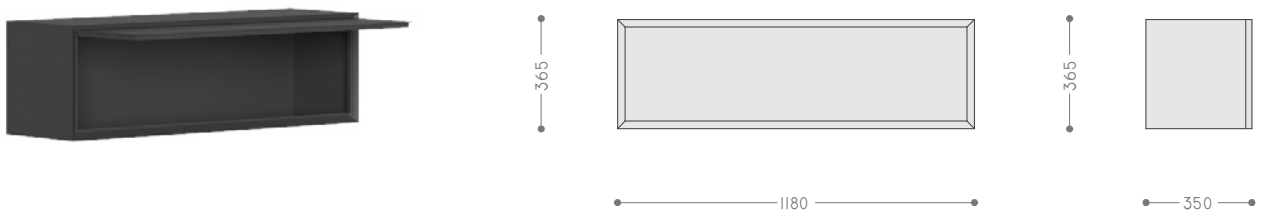

Pensile con anta a ribalta 118x36

Struttura in acciaio zinco magnesio e alluminio (Magnesit), verniciatura bianco RAL 9003 o nero RAL 9004 alte temperature testurizzato. Anta a ribalta con maniglia ad incasso gola, apertura 107° e chiusura blumotion.

Misure 1180x365x350 - peso 20 kg *abbinabile solo al modulo scaffale 120x190

Suspended cabinet with flap door 118x36

Structure in zinc magnesium steel and aluminium (Magnesit), white RAL9003 or black RAL 9004 high temperature, textured painting.

Flap door with recessed handles, 107° opening and blumotion latch.

Dimensions 1180x365x350 - weight 20 kg *only compatible with shelf module 120x190

ELEMENTI D'ARREDO - FURNISHING ELEMENTS

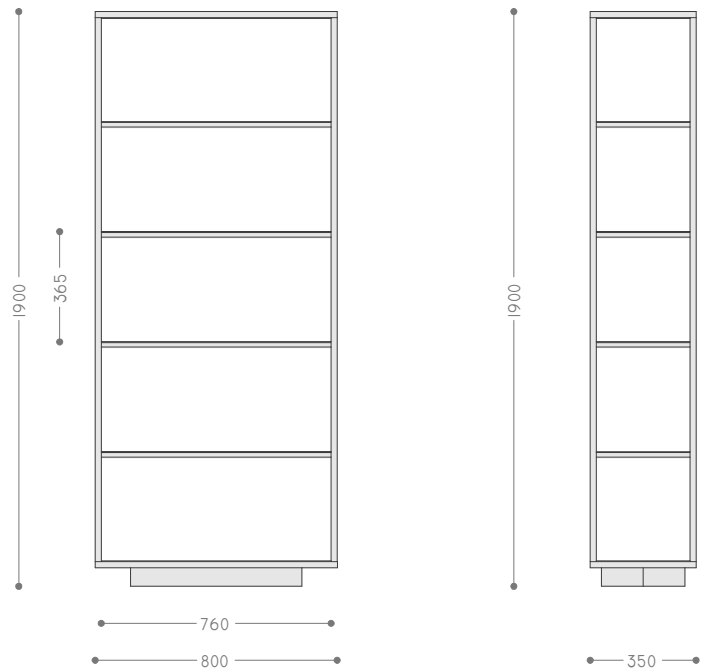

Modulo scaffale 80x190

Struttura in acciaio zinco magnesio e alluminio (Magnesit), verniciatura bianco RAL 9003 o nero RAL 9004 alte temperature testurizzato. Scaffale con mensole metalliche removibili e regolabili. Misure 800x1900x350 - peso 40 kg

Shelf module 80x190

Structure in zinc magnesium steel and aluminium (Magnesit), white RAL 9003 black RAL 9004 high temperature, textured painting. Shelf with removable and adjustable metal shelves. Dimensions: 800x1900x350 - weight 40 kg

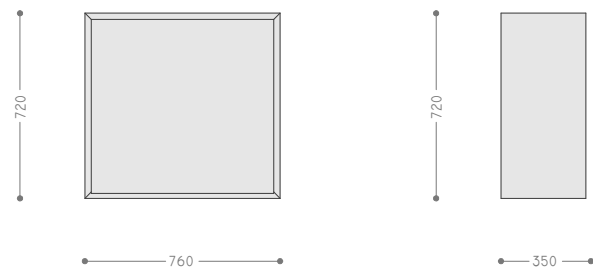

Mobile base 76x72

Struttura in acciaio zinco magnesio e alluminio (Magnesit), verniciatura bianco RAL 9003 o nero RAL 9004 alte temperature testurizzato. Anta a battente con maniglia ad incasso gola, apertura 125° a sgancio rapido e chiusura blumotion.

Misure 760x700x350 - peso 25 kg *abbinabile solo al modulo scaffale 80x190

Cabinet base 76x72

Structure in zinc magnesium steel and aluminium (Magnesit), white RAL 9003 or black RAL 9004 high temperature, textured painting.

Swing door with recessed handles, fast release 125° opening and blumotion latch.

Dimensions 760x700x350 - weight 25 kg *only compatible with shelf module 80x190

ELEMENTI D'ARREDO - FURNISHING ELEMENTS

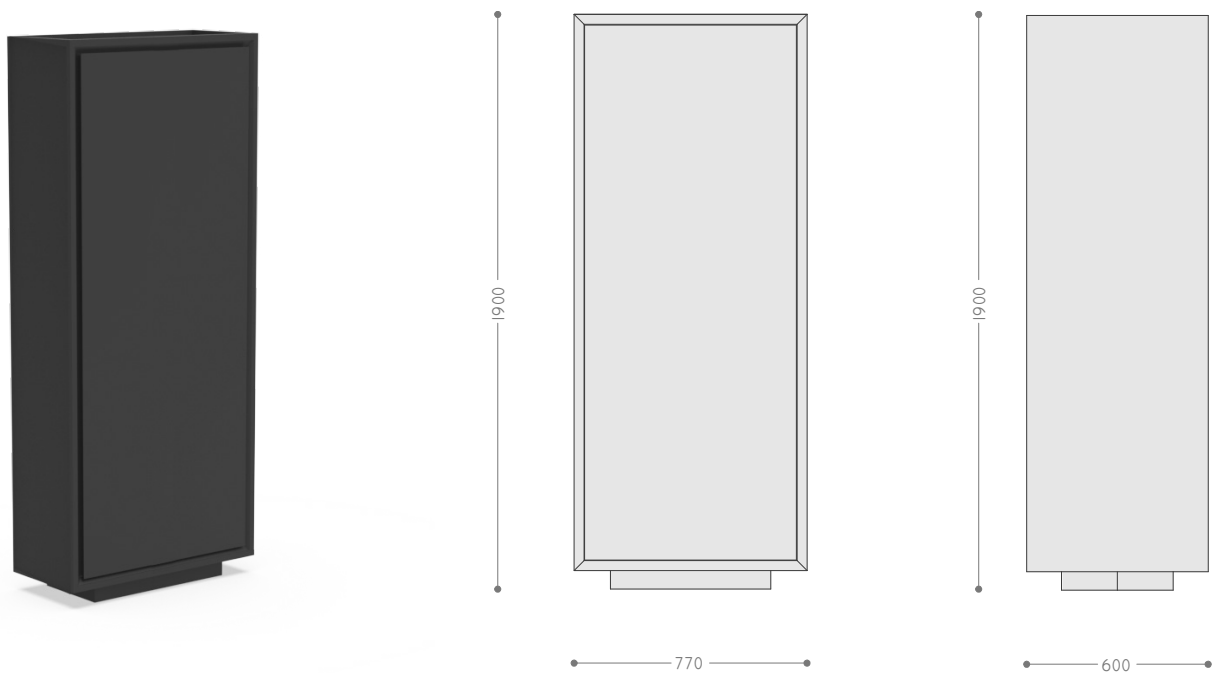

Modulo colonna

Struttura in acciaio zinco magnesio e alluminio (Magnesit), verniciatura bianco RAL 9003 o nero RAL 9004 alte temperature testurizzato. Colonna con mensole metalliche removibili e regolabili. Anta a battente con maniglia ad incasso gola, apertura 125° a sgancio rapido e chiusura blumotion. Misure 770x600x1900 - peso 90 kg

*possibilità di inserire elettrodomestici: frigorifero (596x550x830), lavastoviglie (600x600x820)

Column module

Structure in zinc magnesium steel and aluminium (Magnesit), white RAL 9003 or black RAL 9004 high temperature, textured painting.

Column with removable and adjustable metal shelves.

Swing door with recessed handles, fast release 125° opening and blumotion latch. Dimensions 770x600x1900 - weight 90 kg *possibility of including appliances: fridge (596x550x830) dishwasher (600x600x820)

Led

Optional kit illuminazione a led, nascosto dal battiscopa, ip 65 luce calda 3000K, alimentazione 220w.

Telecomando con dimer di intensità di illuminazione. Disponibile per base 2 moduli, base 3 moduli, base angolo, moduli scaffale e modulo colonna.

Led

Optional led lighting kit, hidden by skirting board, ip 65 warm light 3000K, 220w power supply.

Remote control with lighting intensity dimer. Available for base with 2 modules, base with 3 modules, corner base, shelf module and column module.

ELEMENTI D'ARREDO - FURNISHING ELEMENTS

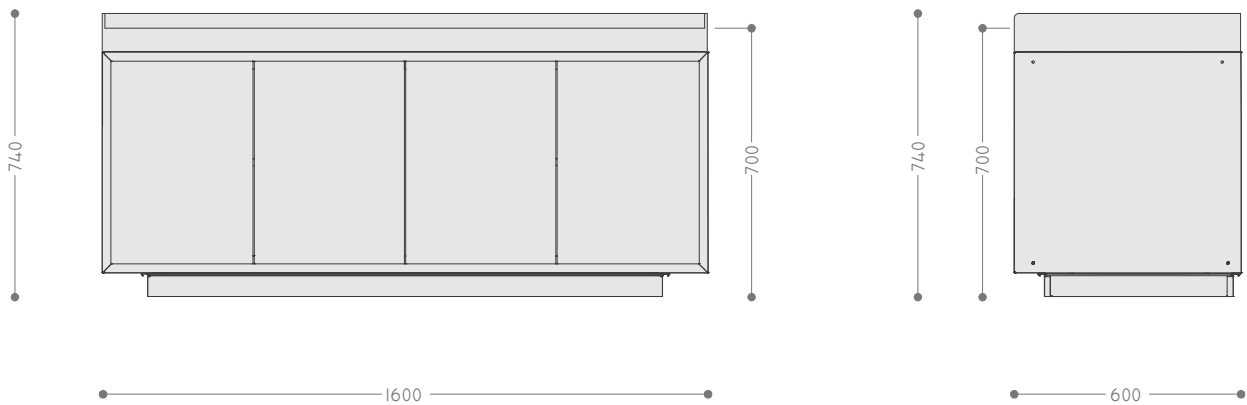

Madia

Struttura in acciaio zinco magnesio e alluminio (Magnesit), verniciatura bianco RAL 9003 o nero RAL 9004 alte temperature testurizzato. 4 ante a battente disponibili o in magnesit o in legno di accoya tinto natural teak con maniglia ad incasso gola, apertura 125° a sgancio rapido e chiusura blumotion. Top in gres.

Misure 1600x600x740 h - peso 130 kg.

Dimensioni interne del vano 65x54x49 h

Kitchen chest

Structure in zinc magnesium steel and aluminium (Magnesit), white RAL 9003 or black RAL 9004 high temperature, textured painting. 4 swing doors available in magnesit or in accoya wood, natural teak colored with recessed handles, fast release 125° opening and blumotion latch. Gres top.

Dimensions: 1600x600x740 h - weight 130 kg. Internal dimensions of the compartment 65x54x49 h

Price list eu
2024

KITCHEN

COMPOSIZIONI CONSIGLIATE - SUGGESTED SET COMBINATIONS

Barbecue + Lavello + Piano neutro / barbecue + sink + neutral countertop

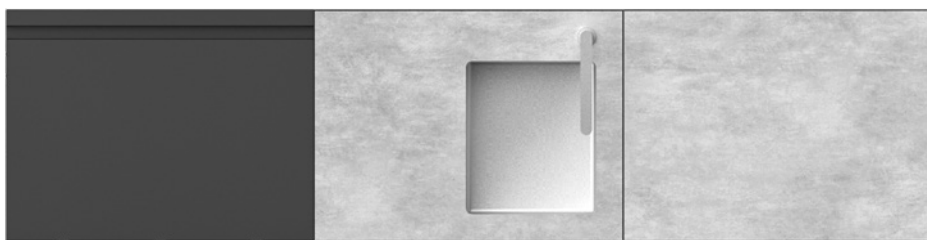

dimensions 2400x600x900

Possibilità di invertire i moduli.
Possibility to mix the modules.

TIKBLPN-01	black colour with doors in magnesit-light grey gres	€ 15.671
TIKBLPN-01-B	white colour with doors in magnesit-warm white gres	
TIKBLPN-02	black colour with doors in accoya wood-light grey gres	€ 16.496
TIKBLPN-02-B	white colour with doors in accoya wood-warm white gres	

Barbecue + Lavello + Piano induzione / barbecue + sink + induction hob

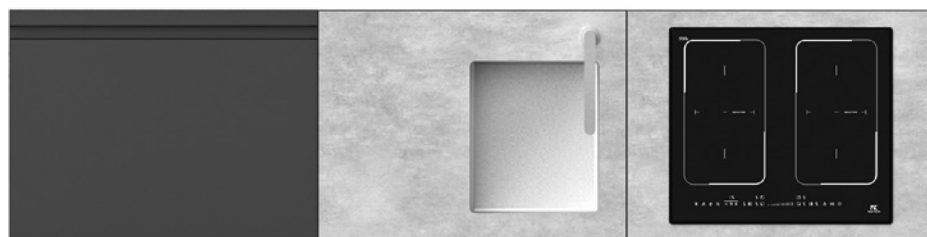

dimensions 2400x600x900

Possibilità di invertire i moduli.
Possibility to mix the modules.

TIKBLPI-01	black colour with doors in magnesit-light grey gres	€ 16.984
TIKBLPI-01-B	white colour with doors in magnesit-warm white gres	
TIKBLPI-02	black colour with doors in accoya wood-light grey gres	€ 17.809
TIKBLPI-02-B	white colour with doors in accoya wood-warm white gres	

Piano induzione + Lavello + Piano neutro / induction hob + sink + neutral countertop

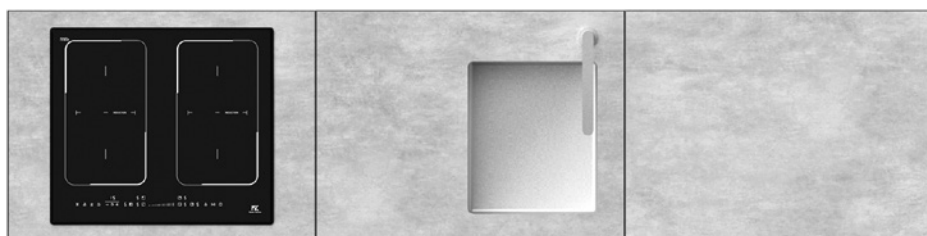

dimensions 2400x600x900

Possibilità di invertire i moduli.
Possibility to mix the modules.

TIKPILPN-01	black colour with doors in magnesit-light grey gres	€ 15.811
TIKPILPN-01-B	white colour with doors in magnesit-warm white gres	
TIKPILPN-02	black colour with doors in accoya wood-light grey gres	€ 16.636
TIKPILPN-02-B	white colour with doors in accoya wood-warm white gres	

COMPOSIZIONI CONSIGLIATE - SUGGESTED SET COMBINATIONS

Barbecue con coperchio + Lavello + Piano neutro / barbecue with lid + sink + neutral countertop

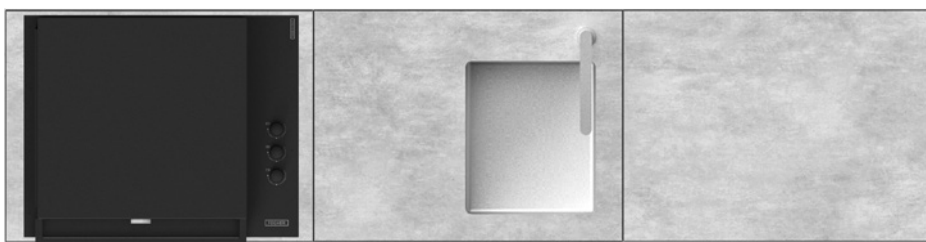

dimensions 2400x600x900

Possibilità di invertire i moduli.
Possibility to mix the modules.

TIKBQLPN-01	black colour with doors in magnesit-light grey gres	€ 17.968
TIKBQLPN-01-B	white colour with doors in magnesit-warm white gres	
TIKBQLPN-02	black colour with doors in accoya wood-light grey gres	€ 18.793
TIKBQLPN-02-B	white colour with doors in accoya wood-warm white gres	

Barbecue con coperchio + Lavello + Piano induzione / barbecue with lid + sink + induction hob

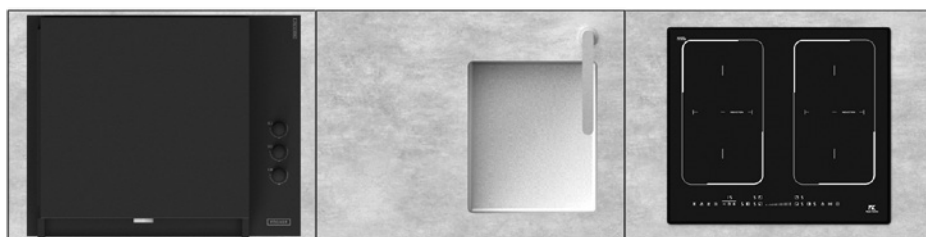

dimensions 2400x600x900

Possibilità di invertire i moduli.
Possibility to mix the modules.

TIKBQLPI-01	black colour with doors in magnesit-light grey gres	€ 19.457
TIKBQLPI-01-B	white colour with doors in magnesit-warm white gres	
TIKBQLPI-02	black colour with doors in accoya wood-light grey gres	€ 20.282
TIKBQLPI-02-B	white colour with doors in accoya wood-warm white gres	

COMPOSIZIONI CONSIGLIATE - SUGGESTED SET COMBINATIONS

Piano snack / *Snack*

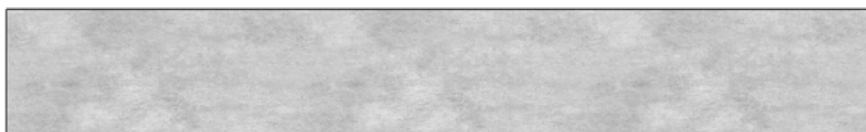

dimensions 2400x350x130

TIKPS3-01	black with light grey gres	€ 2.885
TIKPS3-01-B	white with warm white gres	

Piano snack + Piano penisola / *Snack + peninsula*



dimensions 3600x950x900

Penisola non applicabile al modulo barbecue.
Peninsula cannot be linked to the barbecue module.

TIKPSPP-01	black with light grey gres	€ 5.485
TIKPSPP-01-B	white with warm white gres	

Base angolo con piano lavoro / *Corner base with neutral countertop*

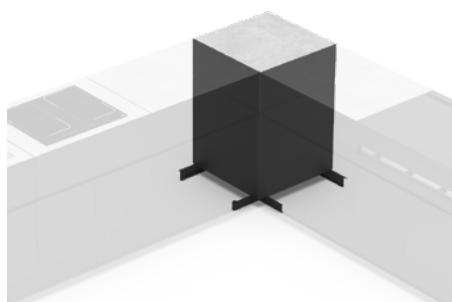

dimensions 600x600x900

TIKANG-01	black with light grey gres	€ 3.982
TIKANG-01-B	white with warm white gres	

La base angolo non è predisposta per l'applicazione di penisola o snack.
Utilizzabile esclusivamente come connessione tra basi 2 moduli e basi 3 moduli.
The corner base is not suitable for peninsula or snack bar and can be used as a connector between bases with 3 modules or/and bases with 2 modules.

COMPOSIZIONI CONSIGLIATE - SUGGESTED SET COMBINATIONS

Barbecue + Lavello / barbecue + sink

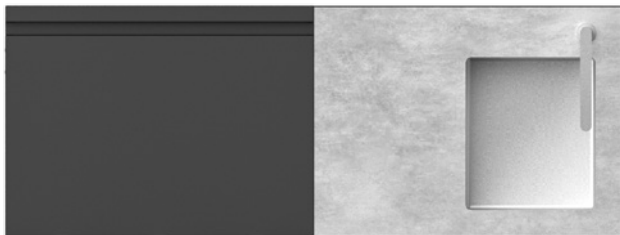

dimensions 1600x600x900

Possibilità di invertire i moduli.
Possibility to mix the modules.

TIKBL-01	black colour with doors in magnesit-light grey gres	€ 11.987
TIKBL-01-B	white colour with doors in magnesit-warm white gres	
TIKBL-02	black colour with doors in accoya wood-light grey gres	€ 12.537
TIKBL-02-B	white colour with doors in accoya wood-warm white gres	

Lavello + Piano induzione / Sink + induction hob

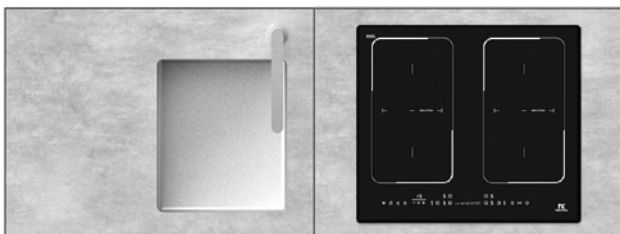

dimensions 1600x600x900

Possibilità di invertire i moduli.
Possibility to mix the modules.

TIKLPI-01	black colour with doors in magnesit-light grey gres	€ 12.130
TIKLPI-01-B	white colour with doors in magnesit-warm white gres	
TIKLPI-02	black colour with doors in accoya wood-light grey gres	€ 12.860
TIKLPI-02-B	white colour with doors in accoya wood-warm white gres	

Barbecue + Piano neutro / barbecue + neutral countertop

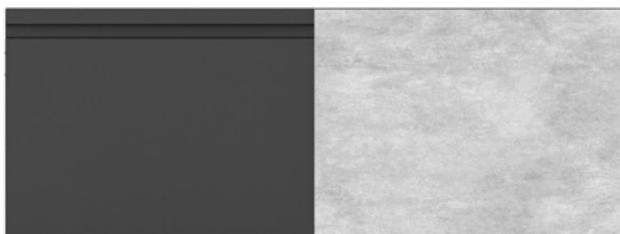

dimensions 1600x600x900

Possibilità di invertire i moduli.
Possibility to mix the modules.

TIKBPN-01	black colour with doors in magnesit-light grey gres	€ 10.542
TIKBPN-01-B	white colour with doors in magnesit-warm white gres	
TIKBPN-02	black colour with doors in accoya wood-light grey gres	€ 11.092
TIKBPN-02-B	white colour with doors in accoya wood-warm white gres	

COMPOSIZIONI CONSIGLIATE - SUGGESTED SET COMBINATIONS

Barbecue con coperchio + Lavello / *barbecue with lid + sink*



dimensions 1600x600x900

Possibilità di invertire i moduli.
Possibility to mix the modules.

TIKBQL-01	black colour with doors in magnesit-light grey gres	€ 14.352
TIKBQL-01-B	white colour with doors in magnesit-warm white gres	
TIKBQL-02	black colour with doors in accoya wood-light grey gres	€ 14.902
TIKBQL-02-B	white colour with doors in accoya wood-warm white gres	

Barbecue con coperchio + Piano neutro / *barbecue with lid + neutral countertop*



dimensions 1600x600x900

Possibilità di invertire i moduli.
Possibility to mix the modules.

TIKBQPN-01	black colour with doors in magnesit-light grey gres	€ 12.793
TIKBQPN-01-B	white colour with doors in magnesit-warm white gres	
TIKBQPN-02	black colour with doors in accoya wood-light grey gres	€ 13.344
TIKBQPN-02-B	white colour with doors in accoya wood-warm white gres	

Lavello + Piano neutro / *Sink + neutral countertop*

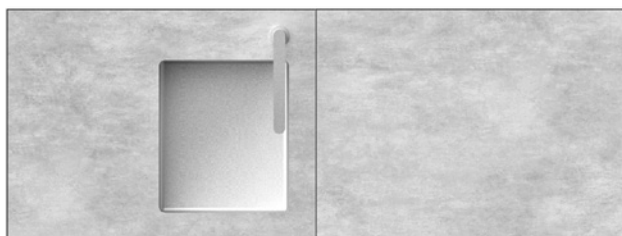

dimensions 1600x600x900

Possibilità di invertire i moduli.
Possibility to mix the modules.

TIKLPN-01	black colour with doors in magnesit-light grey gres	€ 10.414
TIKLPN-01-B	white colour with doors in magnesit-warm white gres	
TIKLPN-02	black colour with doors in accoya wood-light grey gres	€ 11.014
TIKLPN-02-B	white colour with doors in accoya wood-warm white gres	

COMPOSIZIONI CONSIGLIATE - SUGGESTED SET COMBINATIONS

Piano snack / *Snack*



dimensions 1600x350x130

TIKPS2-01	black with light grey gres	€ 2.499
TIKPS2-01-B	white with warm white gres	

ELEMENTI D'ARREDO - FURNISHING ELEMENTS



Modulo scaffale 120x190 / Shelf module 120x190

dimensions 1220x1900x350



TIKSCA120-G black colour with doors in magnesit
TIKSCA120-B white colour with doors in magnesit

€ 4.722



Pensile con anta a ribalta 118x36 / Suspended cabinet with flap door 118x36

dimensions 1180x365x350



TIKSCA120-P-G black colour with doors in magnesit
TIKSCA120-P-B white colour with doors in magnesit

€ 1.475



N°2 Mensole scaffale 120x35 / N°2 Shelf for module 120x35

dimensions 1180x50x350



TIKSCA120-M-G black colour with doors in magnesit
TIKSCA120-M-B white colour with doors in magnesit

€ 812



Kit giunzione scaffali + zoccoli aggiuntivi / Shelf joint kit + additional plinths

dimensions 300x150x60



TIKSCAKIT-G black colour with doors in magnesit
TIKSCAKIT-B white colour with doors in magnesit

€ 281

ELEMENTI D'ARREDO - FURNISHING ELEMENTS

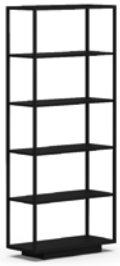

Modulo scaffale 80x190 / Shelf module 80x190

dimensions 800x1900x350



TIKSCA80-G black colour with doors in magnesit
TIKSCA80-B white colour with doors in magnesit

€ 4.034



Mobile base 76x70 / Cabinet base 76x70

dimensions 760x700x350



TIKSCA80-B-G black colour with doors in magnesit
TIKSCA80-B-B white colour with doors in magnesit

€ 1.302



N°2 Mensole scaffale 80x35 / N°2 Shelf for module 80x35

dimensions 800x1900x350



TIKSCA80-M-G black colour with doors in magnesit
TIKSCA80-M-B white colour with doors in magnesit

€ 693



Modulo colonna / Column module

dimensions 770x600x1900



TIKMC-G black colour with doors in magnesit
TIKMC-B white colour with doors in magnesit

€ 4.163



Madia / Kitchen chest (TIKMAD)

dimensions 1600x600x740



TIKMAD-01 black colour with doors in magnesit-light grey gres
TIKMAD-01-B white colour with doors in magnesit-warm white gres
TIKMAD-02 black colour with doors in accoya wood-light grey gres
TIKMAD-02-B white colour with doors in accoya wood-warm white gres

€ 8.003

€ 8.553

ACCESSORI DISPONIBILI - AVAILABLE OPTIONAL

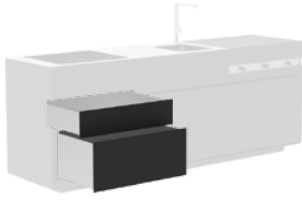

Cassettiera / Drawer

dimensions 665x475x110

dimensions 665x475x210



15



0,12

TIKACDR-01 black colour with doors in magnesit-light grey gres

TIKACDR-01-B white colour with doors in magnesit-warm white gres

€ 3.078



Frigorifero / fridge (TIKACFR-01)

dimensions 660x590x467



38



0,22

TIKACFR-01-EXT-G side fridge module with black colour frame

TIKACFR-01-EXT-B side fridge module with white colour frame

TIKACFR-01-CX-G central fridge module with black colour frame

TIKACFR-01-CX-B central fridge module with white colour frame

€ 3.182



Cantinetta / Wine fridge (TIKACW-01)

dimensions 510x260x470



11



0,08

€ 504



Frigorifero mini bar / Minibar fridge (TIKACM-01)

dimensions 350x385x463



12



0,09

€ 873



Macchina per il ghiaccio / Ice maker (TIKACI-01)

dimensions 240x360x320



11



0,06

€ 477

Tagliere copri lavello (TIKACT-01)

dimensions 360x420x20



1



0,01

€ 240

Tagliere copri piano induzione (TIKACT-02)

dimensions 620x550x20



1



0,01

€ 240

ACCESSORI DISPONIBILI - AVAILABLE OPTIONAL

Kit luci (2 moduli) / Lights kit (2 modules) (TIKACL-01)	€ 741
Kit luci (3 moduli) / Lights kit (3 modules) (TIKACL-02)	€ 856
Kit luci (angolo) / Lights kit (corner) (TIKACL-03)	€ 429
Kit luci (modulo colonna) / Lights kit (column module) (TIKACL-04)	€ 485
Piastra / Hotplate (TIKACPI-01)	€ 138
Griglia / Grill (TIKACGR-02)	€ 370
Pietra ollare / Soapstone (TIKACPO-01)	€ 242
Cover: (consegna 4-6 settimane / delivey 4-6 week) Composizione 2 moduli / assembly with 2 modules (TIKACCOP-01)	€ 485
Composizione 2 moduli + Piano snack (TIKACCOP-02) Assembly with 2 modules + snack	€ 569
Composizione 3 moduli / assembly with 3 modules (TIKACCOP-03)	€ 581
Composizione 3 moduli + Piano snack (TIKACCOP-04) Assembly with 3 modules + snack	€ 663
Composizione 3 moduli + Piano snack + penisola (TIKACCOP-05) Assembly with 3 modules + snack + peninsula	€ 801

ACCESSORI DISPONIBILI - AVAILABLE OPTIONAL

Kit ricambio ugelli FGA "A" / nozzle replacement kit FGA "A" (TIKACN-01) UGELLI PREINSTALLATI IN DOTAZIONE / PRE-INSTALLED NOZZLES SUPPLIED

Gas: G20 (GAS GPL) - Category: I3B/P(30), I3+(28..30/37) € 60
Country: AL, BE, BG, CH, CY, CZ, DK, EE, ES, FI, FR, GB, GR, HR, HU, IS, IE, IT, LT, LU, LV, MK, MT, NL,
NO, PT, RO, SE, SI, SK, TR

Kit ricambio ugelli FGA "B" / nozzle replacement kit FGA "B" (TIKACN-02)

Gas: G30/31 (GAS GPL) - Category: I3B, P(37) € 60
Country: PL

Kit ricambio ugelli FGA "C" / nozzle replacement kit FGA "C" (TIKACN-03)

Gas: G20 (GAS GPL) - Category: I3B, P(50) € 68
Country: AT, DE, CH, SK

Kit ricambio ugelli FGA "D" / nozzle replacement kit FGA "D" (TIKACN-04)

Gas: G20 (GAS METANO) - Category: I2H, I2E, I2E+ € 60
Country: AL, AT, BE, BG, CH, CY, CZ, DK, EE, FI, FR, GB, GR, HR, HU, IE, IT, LT, LU, LV, MK, NO, PL,
PT, RO, SE, SI, SK, SP, TR

Kit ricambio ugelli FGA "E" / nozzle replacement kit FGA "E" (TIKACN-05)

Gas: G25.1 (GAS METANO) - Category: I2S € 68
Country: HU

Kit ricambio ugelli FGA "F" / nozzle replacement kit FGA "F" (TIKACN-06)

Gas: G25.1 (GAS METANO) - Category: I2S € 60
Country: HU

ACCESSORI DISPONIBILI - AVAILABLE OPTIONAL

Kit ricambio ugelli FGA "G" / nozzle replacement kit FGA "G" (TIKACN-07)

Gas: G20 (GAS METANO) - Category: I2H, P(25)
Country: HU

€ 60

Kit ricambio ugelli FGA "H" / nozzle replacement kit FGA "H" (TIKACN-08)

Gas: G20 (GAS METANO) - Category: I2H, P(25)
Country: NL

€ 60

USO E MANUTENZIONE - AVAILABLE OPTIONAL

Magnesit

Manutenzione: Per mantenere a lungo il prodotto in buone condizioni, consigliamo una corretta pulizia periodica, particolarmente frequente in località caratterizzate da forte umidità e clima marino. Si raccomanda di pulire le superfici con un panno morbido utilizzando acqua o detersivi neutri. Prolungate ed ininterrotte esposizioni a intense radiazioni UV o a temperature molto rigide possono incidere sulle caratteristiche iniziali del rivestimento estetico colorato costituito da poliestere.

Consigliamo di pulire e conservare in luoghi riparati i prodotti durante periodi d'inutilizzo prolungato e invernali.

Maintenance: To keep the product in good condition for a long time, we recommend a regular cleaning period, particularly frequent in places characterized by high humidity and marine climate. We recommend cleaning the surfaces with a soft cloth using water or neutral detergents. Prolonged and uninterrupted exposures to intense UV radiation or at very low temperatures can affect the initial characteristics of the colored polyester coating. We recommend cleaning and storing products in sheltered areas during long periods of non-use and winter.

Gres

Per la pulizia dei piani in gres si consiglia l'utilizzo di un panno inumidito con acqua e detersivo neutro da risciacquare ed asciugare con un panno asciutto. Nella fase di lavaggio porre particolare attenzione al fine di evitare l'accumulo di sporco o calcare.

Maintenance: For the cleaning of stoneware tops it is advisable to use a damp cloth with water and a neutral detergent to be rinsed and dried with a dry cloth. During the washing phase, pay particular attention to avoid the accumulation of dirt.

GENERAL CONDITIONS OF SALE DELIVERY INCLUDED

1. The colours, drawings and sizes of the products in this catalogue are approximate. Talenti spa reserves the right to discontinue or change the models in its collections at any time without advance notice.

2. The prices of the standard models are expressed in the specific price list that Talenti spa will provide. Concerning customized items the offer will be immediately made and provided by Talenti spa on request of the customer.

Prices are ex works. In case of delivery with hydraulic bank the quotations of our freight forwarder will be applied.

3. The purchaser is always required to inspect the goods and indicate on the transport document the date of receipt, the person who received it and the company's stamp, as well as any anomalies found in the material. Talenti spa will not accept any claims presented more than 5 (five) days after receipt of the goods.

4. Orders must be in writing using the codes, descriptions and prices shown in the catalogue and price lists.

5. Transport terms in France, Germany, Switzerland, Austria:

Free port for orders starting from € 1.800,00.

For orders under € 600,00 a € 80,00 transport fee will be charged.

For orders from € 600,00 to € 1.800,00 a 8 % transport fee will be charged.

6. Transport terms in UK:

Free port for orders over € 3.000,00.

For orders from € 0 to € 1.000,00 a € 90,00 transport fee will be charged.

For orders from € 1.000,00 to € 3.000,00 a 5 % transport fee will be charged.

7. The Court of Terni (Italy) will be exclusively competent for any disagreements.

For different Countries please refer to Talenti sales-managers

NOTICE UNDER DL 196/2003, THE PRIVACY LAW

Your personal information will be handled with respect for your rights and fundamental liberties and with particular reference to confidentiality and the right of protection. Your information will be handled to fulfill our administrative, accounting and tax obligations and to fulfill our contractual obligations. In addition to the company's employees assigned to handle your information internally, it may also be communicated to administrative, accounting and legal consultants and to banks.

The owner of the information for handling purposes is Talenti Spa, which is located at Strada Amerina km 4,5, 05022 - Amelia (Tr) - Italy. You may contact the owner to assert your rights under article 7 of DL 196/2003.